

NEBULA 47

INSTALLATION INSTRUCTIONS

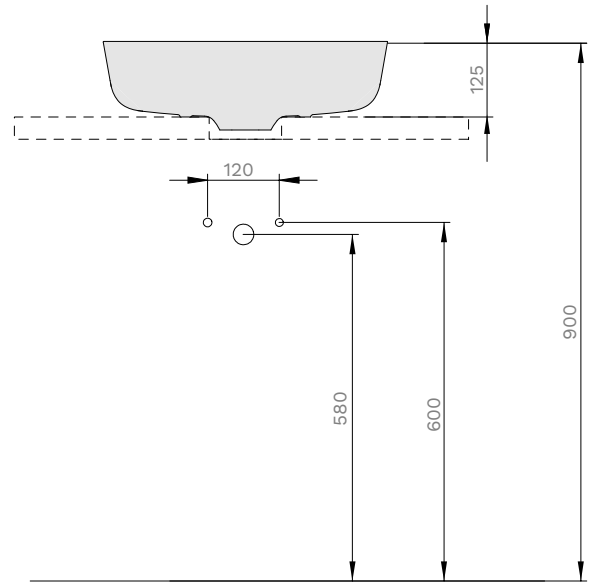
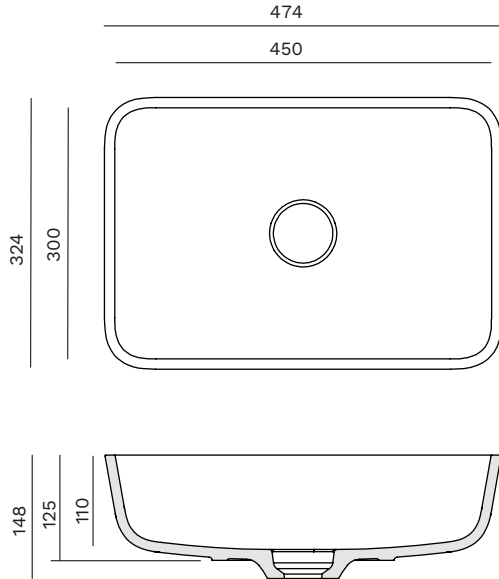

- * DIMENSIONS IN MM
- * DRILLING JIG INCLUDED

CUT DRAWING

